



MAX9765 Evaluation System/Evaluation Kit

General Description

The MAX9765 evaluation system (EV system) consists of a MAX9765 evaluation kit (EV kit) and a companion Maxim System Management Bus (SMBus™) interface board.

The MAX9765 EV kit is a fully assembled and tested surface-mount circuit board that evaluates the MAX9765 750mW stereo audio power amplifier plus headphone driver and microphone amplifier. The EV kit is designed to be driven by any stereo audio source such as a CD player. The MAX9765 EV kit includes RCA jacks and a 3.5mm microphone jack on the inputs as well as a 3.5mm headphone jack and terminal blocks on the output to facilitate easy connections to the circuit board. The MAX9765 EV kit includes Windows®98/2000/XP-compatible software, which provides a user interface for exercising the MAX9765 features.

The MAXSMBus interface board allows an IBM-compatible PC to use its parallel port to emulate an SMBus/I²C™-compatible 2-wire interface. Windows 98/2000/XP-compatible software provides a user-friendly interface to exercise the MAX9765 features. The program is menu driven and offers a graphic interface with control buttons and status display.

The MAX9765EVSYS includes both the MAX9765 EV kit and the MAXSMBus interface board. Order only the MAX9765EVKIT if you already have an SMBus interface board.

SMBus is a trademark of Intel Corp.

Windows is a registered trademark of Microsoft Corp.

I²C is a trademark of Philips Corp. Purchase of I²C components of Maxim Integrated Products, Inc., or one of its sublicensed Associated Companies, conveys a license under the Philips I²C Patent Rights to use these components in an I²C system, provided that the system conforms to the I²C Standard Specification as defined by Philips.

Features

- ◆ 2.7V to 5.5V Single-Supply Operation
- ◆ 750mW Stereo Bridge-Tied-Load (BTL) Amplifier
- ◆ 95dB Power-Supply Rejection Ratio
- ◆ SMBus/I²C-Compatible 2-Wire Serial Interface
- ◆ 2:1 Stereo Input Mux
- ◆ Low-Profile (2.0mm, max) Design
- ◆ No Detectable Clicks or Pops
- ◆ Easy-to-Use, Menu-Driven Software
- ◆ Assembled and Tested
- ◆ Software-Controlled Mute, Input MUX, and Mic Gain
- ◆ Automatic Headphone Sensing Circuitry
- ◆ Includes Windows 98/2000/XP-Compatible Software and Demo PC Board

Ordering Information

PART	TEMP RANGE	IC PACKAGE	SMBus INTERFACE TYPE
MAX9765EVKIT	0°C to +70°C	32 Thin QFN	Not included
MAX9765EVSYS	0°C to +70°C	32 Thin QFN	MAXSMBUS

Note: The MAX9765 EV kit software is provided with the MAX9765EVKIT. However, the MAXSMBUS board is required to interface the EV kit to the computer when using the software.

Component List

DESIGNATION	QTY	DESCRIPTION
C1–C4	4	0.68µF ±10%, 20V tantalum capacitors (R-case) AVX TAJR684K020
C5, C6	2	100pF ±5%, 50V C0G ceramic capacitors (0402) TDK C1005C0G1H101J
C8, C9, C10, C14, C15	5	1.0µF ±20%, 10V X7R ceramic capacitors (0603) TDK C1608X7R1A105M
C11, C12, C13	3	220µF ±20%, 10V tantalum capacitors (Y-case) AVX TPSY227M010R0200 Sprague 592D227X0010V2T

DESIGNATION	QTY	DESCRIPTION
C16	1	1.0µF ±10%, 10V tantalum capacitor (R-case) AVX TAJR105K010
C17, C18	2	100µF ±10%, 6.3V tantalum capacitors (W-case) AVX TAJW107K006
R1–R6	6	15kΩ ±1% resistors (0402)
R7, R8, R9	3	10kΩ ±5% resistors (0402)
R11–R14	4	100kΩ ±5% resistors (0402)
R15	1	680kΩ ±5% resistor (0402)
R16, R17	0	Not installed (0402)
R18	1	2kΩ ±1% resistor (0402)



MAX9765 Evaluation System/Evaluation Kit

Component List (continued)

DESIGNATION	QTY	DESCRIPTION
R19	0	Not installed (0402)
R20	1	47kΩ ±5% resistor (0402)
J1, J3	2	Phono jacks (white)
J2, J4	2	Phono jacks (red)
J5	1	Switched stereo headphone jack (3.5mm dia)
J6	1	2 × 10 right-angle female receptacle
J7	1	Phono jack (black)
J8	1	Nonswitched stereo headphone jack (3.5mm dia)
JU1	1	2-pin header
JU2	1	3-pin header
JU3	1	Jumper (2 × 4 pin header)
TB1, TB2	2	2-circuit terminal blocks
U1	1	MAX9765ETJ (32-pin thin QFN)
None	3	Shunts
None	1	MAX9765 PC board
None	1	Software disk (CD-ROM), MAX9765 Evaluation Kit

Quick Start

Recommended Equipment

- Computer running Windows 98, 2000, or XP
- Parallel printer port (this is a 25-pin socket on the back of the computer)
- Standard 25-pin, **straight-through**, female-to-male cable (printer extension cable) to connect the computer's parallel port to the Maxim SMBus interface board
- A fixed 9V, 100mA DC power supply (for SMBus card)
- DC power supply capable of supplying any voltage between 2.7V and 5.5V at 1A

Functional Diagram

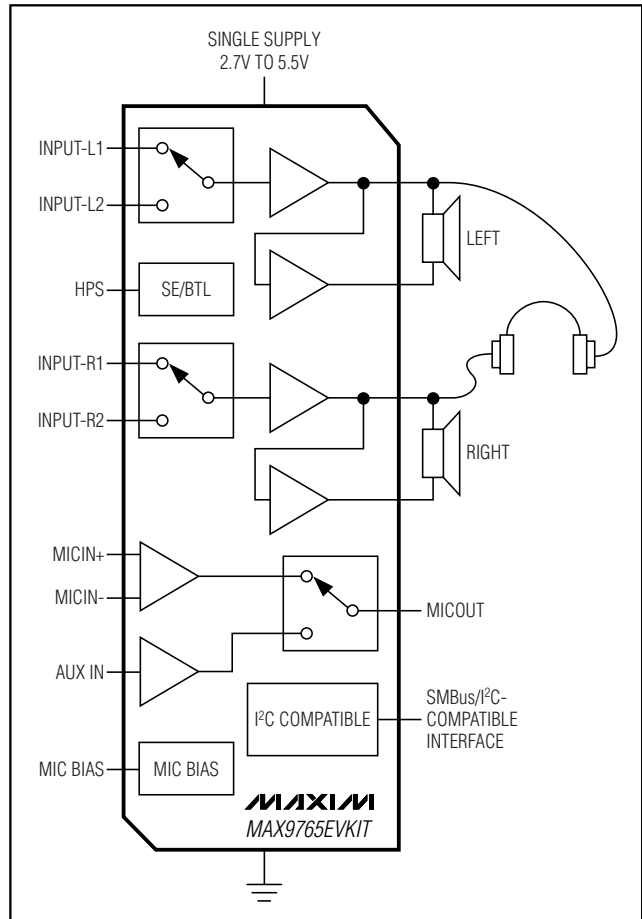

- One pair of headphones (16Ω or greater)
- Two stereo audio sources (to demonstrate the input mux feature)
- One pair of speakers (4Ω or greater)
- Two microphones (to demonstrate the mic amp features)

Component Suppliers

SUPPLIER	PHONE	FAX	WEBSITE
AVX	843-946-0238	843-626-3123	www.avxcorp.com
Sprague	402-563-6866	402-563-6296	www.vishay.com
TDK	847-803-6100	847-390-4405	www.component.tdk.com

Note: Please indicate that you are using the MAX9765 when contacting these component suppliers.

MAX9765 Evaluation System/Evaluation Kit

Procedure

The MAX9765 EV kit is fully assembled and tested. Follow the steps below to verify board operation. **Do not turn on the power supply until all connections are completed:**

- 1) Carefully connect the boards by aligning the 20-pin connector of the MAX9765 EV kit with the 20-pin header of the MAXSMBUS interface board. Gently press them together.
- 2) Connect a cable from the computer's parallel port to the SMBus interface board. Use a **straight-through** 25-pin female-to-male cable. To avoid damaging the MAX9765 EV kit or your computer, do not use a 25-pin SCSI port or any other connector that is physically similar to the 25-pin parallel printer port.
- 3) The MAX9765.EXE software program can be run from the CD-ROM or the hard drive. Use the Windows program manager to run the program. If desired, you may use the INSTALL.EXE program to copy the files and create icons in the Windows 98/2000/XP Start menu. **Do not turn on the power until all connections are made.**
- 4) Connect the 9V power supply to the pads labeled POS9 and GND1 of the SMBus interface board.
- 5) Connect the 2.7V to 5.5V power supply to the pads labeled VDD and GND on the MAX9765 EV kit board.
- 6) Adjust the 2.7V to 5.5V power supply to 3.0V.
- 7) Ensure that both stereo audio sources are turned off.
- 8) Connect the first stereo audio source to the input jacks labeled J1 and J2.
- 9) Connect the second stereo audio source to the input jacks labeled J3 and J4.
- 10) Plug the headphones into the 3.5mm headphone jack labeled J5.
- 11) Connect the speakers to the terminal blocks labeled TB1 and TB2.
- 12) Connect a differential microphone to the pads marked MICIN+ and MICIN-, and/or connect a single-ended microphone to the 3.5mm jack labeled J8.
- 13) Ensure that a shunt is installed on jumper JU1.
- 14) Ensure that shunts are installed across pins 1 and 2 of jumpers JU2 and JU3.
- 15) Turn on the DC power supplies.
- 16) Enable the stereo audio sources.

- 17) Start the MAX9765 program by opening its icon in the Start menu.
- 18) Observe as the program automatically detects the address of the MAX9765 and starts the main program.
- 19) The MAX9765 features can be controlled by using the provided software. The *Detailed Description of Software* section outlines how to use these functions.

Detailed Description of Software

User-Interface Panel

The MAX9765 EV kit software provides an easy user interface (Figure 1) to control and read back the programmable features of this device. Each of the buttons and control sliders correspond to bits in the command and configuration bytes. By clicking on them, the correct I²C/SMBus write operation is generated to update the internal registers of the MAX9765. The **Interface** box indicates the current **Device Address**, the **Register Address**, and the **Data Sent/Received** for the last read/write operation. This data is used to confirm proper device operation.

Note: Words in boldface are user-selectable features in the software.

Signal Input Selection

The MAX9765 EV kit can route one of two independent stereo signals to the speakers or headphones. The input signal is selected by choosing the desired option in the **Signal Input Selection** box. Choosing **Signal Input #1** routes the signal from input jacks J1 and J2. Choosing **Signal Input #2** routes the signal from input jacks J3 and J4.

Microphone Control

The MAX9765 EV kit is capable of amplifying both a single-ended microphone and a differential microphone. Selecting the **Differential Mode (internal)** option located in the **Microphone Input Selection** box evaluates a differential microphone connected to the MICIN+ and MICIN- pads. Selecting the **Single-Ended Mode (external)** option evaluates a single-ended microphone connected to the AUXIN and MICBIAS pads or through microphone jack J8. Microphone jack J8 conforms to a standard notebook PC (Figure 2).

The MAX9765 EV kit software also controls the microphone amplifier gain through the 2-wire interface.

The microphone amplifier gain can be adjusted by the **Gain** slider in the **Microphone Control** box.

MAX9765 Evaluation System/Evaluation Kit

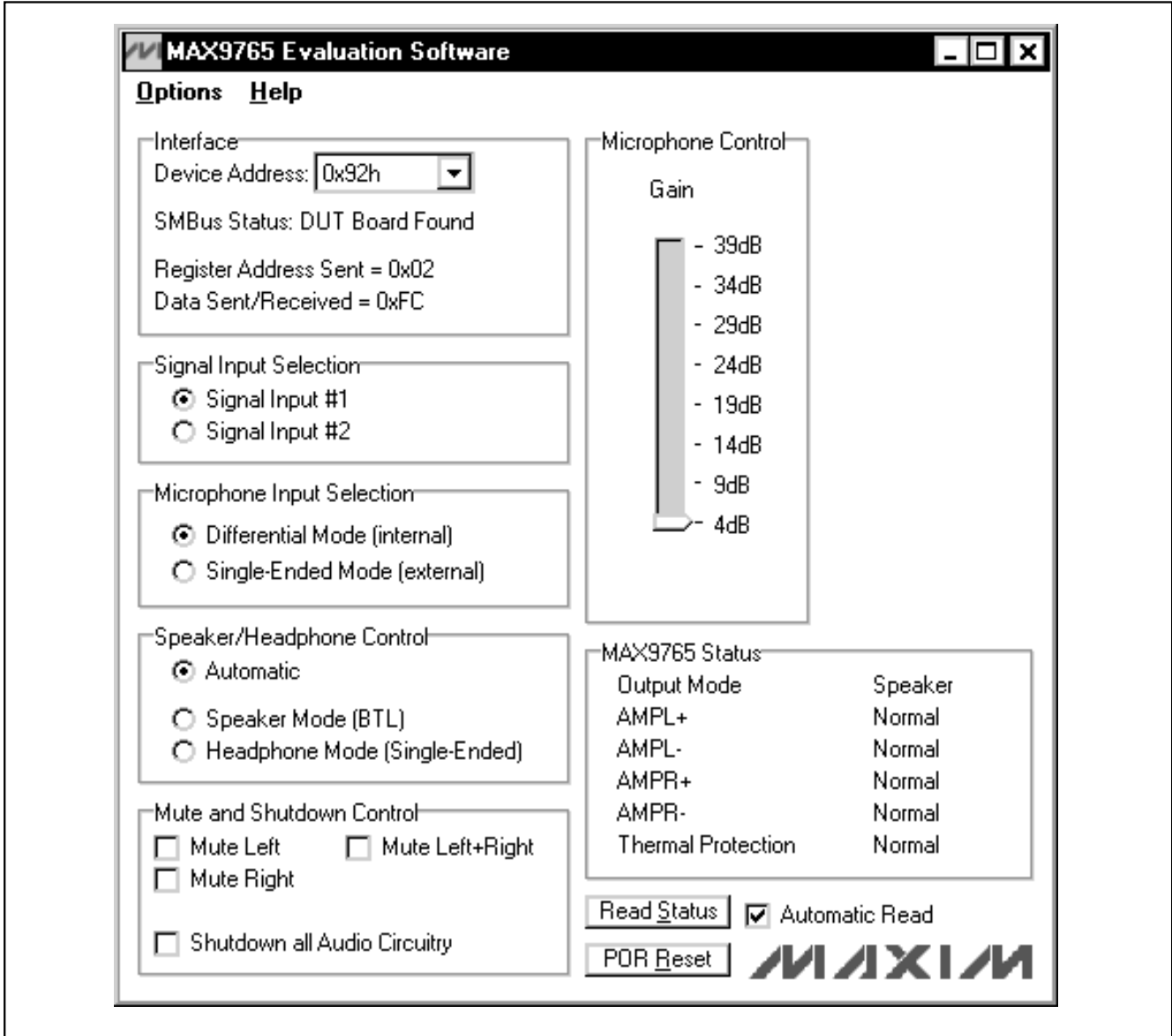

Figure 1. MAX9765 EV Kit Software Main Window

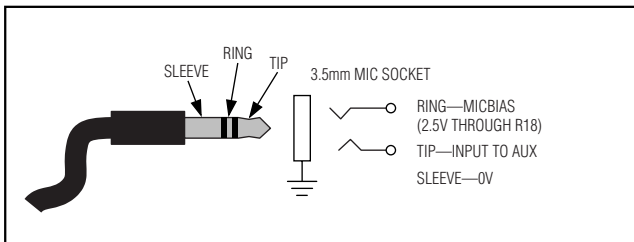

Figure 2. Notebook PC Microphone Connection Diagram

Speaker/Headphone Control

Selecting the desired option in the **Speaker/Headphone Control** box allows the MAX9765 EV kit to operate in one of three independent modes. The **Automatic** mode (default) detects the insertion of the headphones in jack J5. The speaker outputs are disabled if the headphones are present, and enabled if the headphones are absent. Selecting the **Speaker Mode (BTL)** provides drive to the speakers and head-

MAX9765 Evaluation System/Evaluation Kit

phones (if both are present). Selecting the **Headphone Mode (Single-Ended)** provides drive to the headphones only.

MAX9765 Status

The program continually polls the device for new status data and updates the MAX9765 status window. To disable continuous polling of data, uncheck the **Automatic Read** checkbox.

Software Mute and Shutdown Control

Selecting the desired option in the **Mute and Shutdown Control** box allows the MAX9765 EV kit to disable the left, right, or both output channels. Checking the **Mute Left** option mutes the left channel. Checking the **Mute Right** option mutes the right channel. Checking the **Mute Left+Right** option mutes both channels.

Checking the **Shutdown all Audio Circuitry** places the MAX9765 into a low-power software shutdown mode. In this mode, all the I²C registers are still active.

Simple SMBus Commands

There are two methods for communicating with the MAX9765: through the normal user-interface panel or through the SMBus commands available by selecting the **Two Wire Interface Diagnostics** item from the Interface pulldown menu. A display pops up that allows the SMBus protocols, such as Read Byte and Write Byte, to be executed. To stop normal user-interface execution so that it does not override the manually set values, turn off the update timer by unchecking the **Automatic Read** checkbox.

The SMBus dialog boxes accept numeric data in binary, decimal, or hexadecimal. Hexadecimal numbers should be prefixed by \$ or 0x. Binary numbers must be exactly eight digits. See Figure 3 for an example of this tool.

Note: In places where the slave address asks for an 8-bit value, it must be the 7-bit slave address of the MAX9765 as determined by the ADD pin with the last bit set to 1 for a read operation and zero for a write. Refer to the MAX9765 data sheet for a complete list of registers and functions.

Evaluates: MAX9765

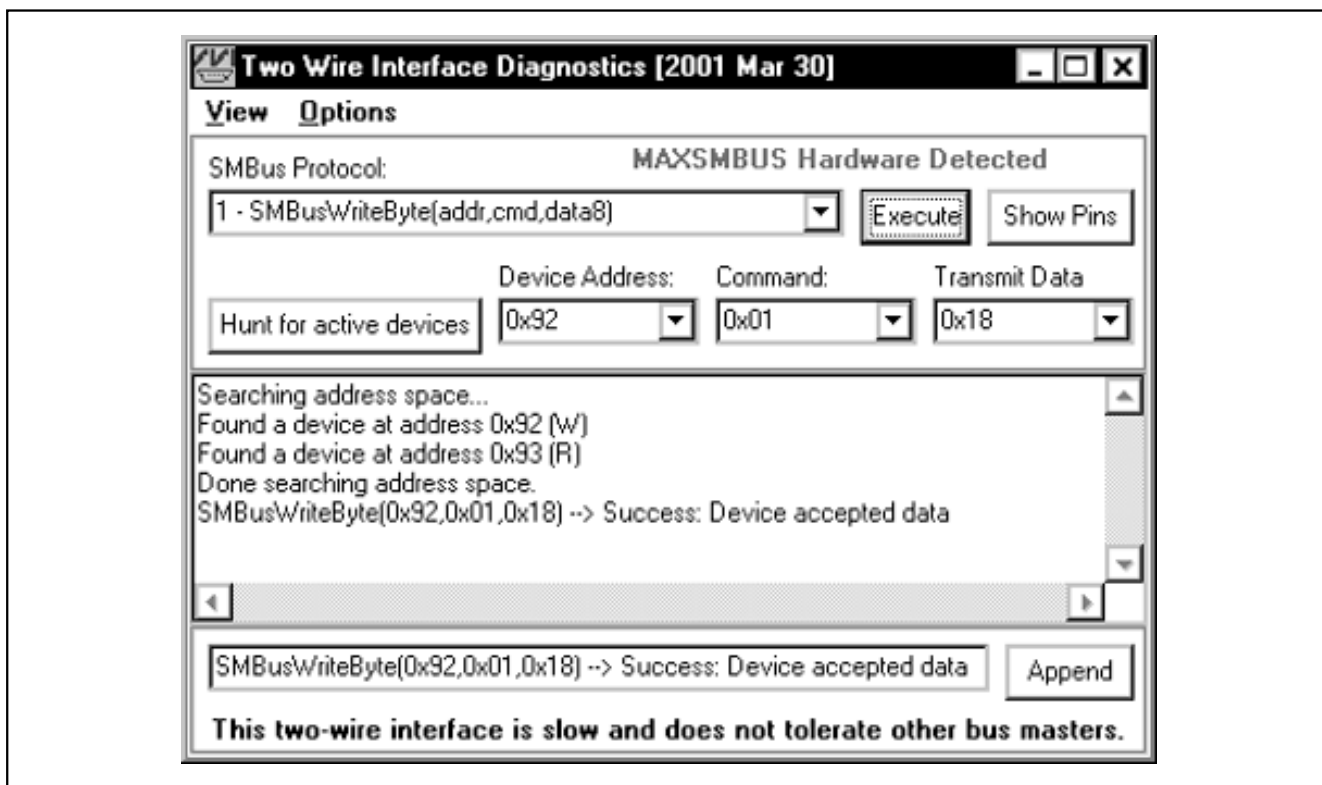

Figure 3. Simple SMBusWriteByte Operation Using the Included 2-Wire Interface Diagnostics. (In this example, the software is writing data (0x18) to Device Address 0x92, Register Address 0x01. The above data sequence mutes both MAX9765 output channels.)

MAX9765 Evaluation System/Evaluation Kit

Detailed Description of Hardware

The MAX9765 EV kit is a stereo, single-supply speaker/headphone/microphone amplifier. The MAX9765 EV kit is designed to be driven by any stereo audio source.

The input impedance is 15k Ω . The MAX9765 EV kit is shipped with components selected to produce a unity gain and can be powered with a 2.7V to 5.5V supply. A bandpass filter is implemented on the MAX9765 EV kit. The -3dB corner frequencies are approximately 16Hz and 106kHz and are dependent on components R1–R6, C1–C6.

Multiple input and output jacks facilitate easy connections to the board. Connect the speakers to terminal blocks TB1 and TB2. Connect the two stereo input sources through jacks J1–J4. Connect the headphones through J5. Connect the microphone to the MICIN+/MICIN- pads or through the input jack (J8). The amplified microphone output appears on the pad labeled OUT or on J7.

MAX9765 Address Selection

There are four possible I²C/SMBus addresses (refer to the MAX9765 data sheet for details). Jumper JU1 sets the MAX9765 slave address. The default address is 1001 001Y (ADD = VCC). See Table 1 for a complete list of addresses.

Note: The first 7 bits shown are the address. Y (bit 0) is the SMBus read/write bit. This bit is a 1 for a read operation and a zero for a write.

Hardware Shutdown Control

Jumper JU2 controls the hardware shutdown function of the MAX9765 EV kit. This shuts down the MAX9765 I²C/SMBus interface and resets all the registers to their power-on defaults (see Table 2 for shutdown shunt positions).

Manual Headphone Sense Control

Removing the shunt from jumper JU1 simulates a pair of headphones being inserted into the headphone jack by forcing the HPS pin to a logic high. Connect the load to the LEFT, RIGHT, and GND pads located by headphone jack J5 (see Table 3 for jumper settings).

Table 1. Shunt Settings for SMBus Address

JUMPER	SHUNT POSITION	MAX9765 ADDRESS PIN	MAX9765 ADDRESS	
			BINARY	HEXADECIMAL
JU3	1–2*	VDD	1001 001Y	0x92h
JU3	3–4	SCL	1001 011Y	0x96h
JU3	5–6	SDA	1001 010Y	0x94h
JU3	7–8	SGND	1001 000Y	0x90h

*Default configuration

Table 2. Shutdown Selection

JUMPER	SHUNT POSITION	DESCRIPTION
JU2	1–2*	MAX9765 enabled
JU2	2–3	MAX9765 shut down

*Default configuration

Table 3. Manual Headphone Sense Control

JUMPER	SHUNT POSITION	DESCRIPTION
JU1	Installed*	MAX9765 EV kit headphone sense controlled by the insertion of headphones
JU1	Not installed	MAX9765 EV kit headphone sense switch forced open

*Default configuration

Using the MAX9765 EV Kit with an SMBus Interface

A user-supplied I²C/SMBus interface may be used with the MAX9765 EV kit. If the interface does not have pullup resistors on the clock or data lines, additional pads are provided on the EV kit for this purpose. To ensure that the clock and data lines are pulled up to the correct voltage levels, solder 1k Ω \pm 5% resistors in locations R16 and R17.

MAX9765 Evaluation System/Evaluation Kit

Evaluates: MAX9765

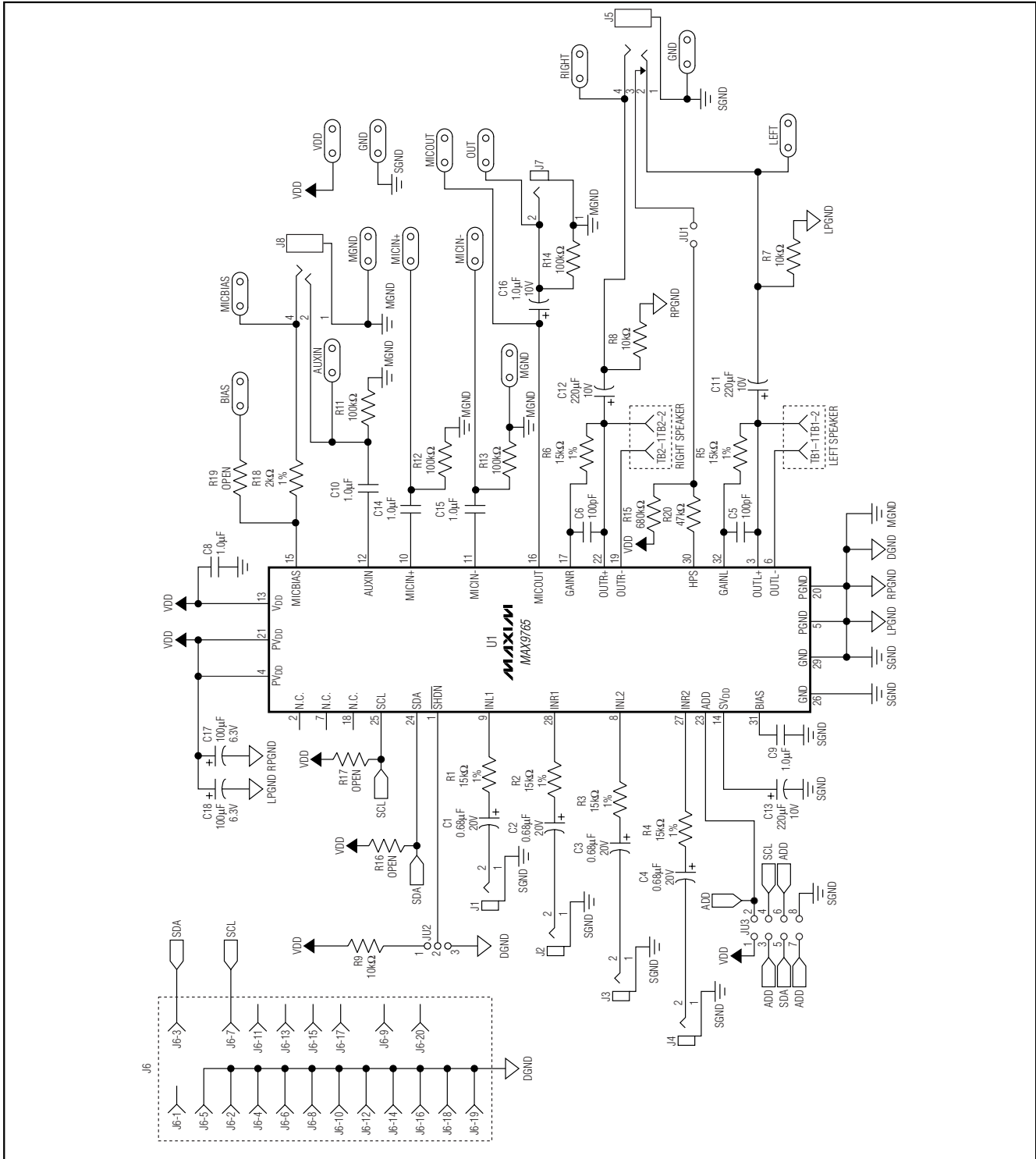

Figure 4. MAX9765 EV Kit Schematic

MAX9765 Evaluation System/Evaluation Kit

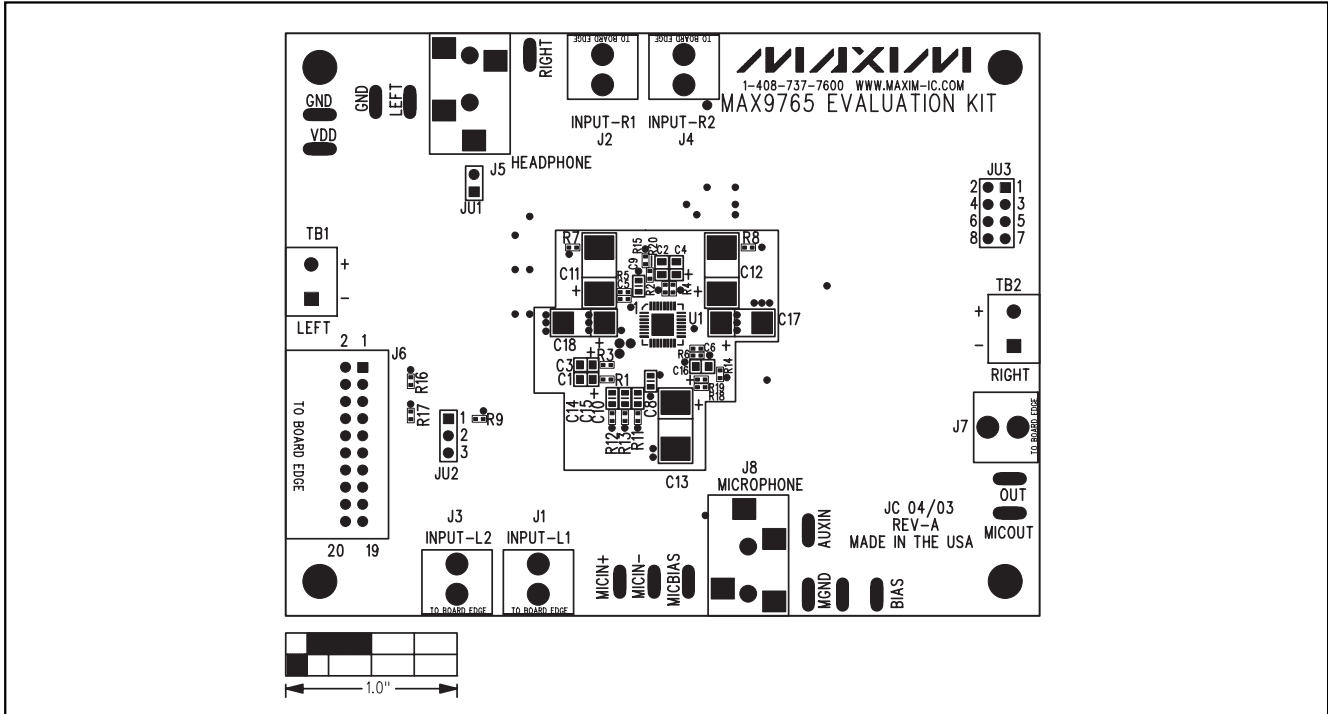

Figure 5. MAX9765 EV Kit Component Placement Guide—Component Side

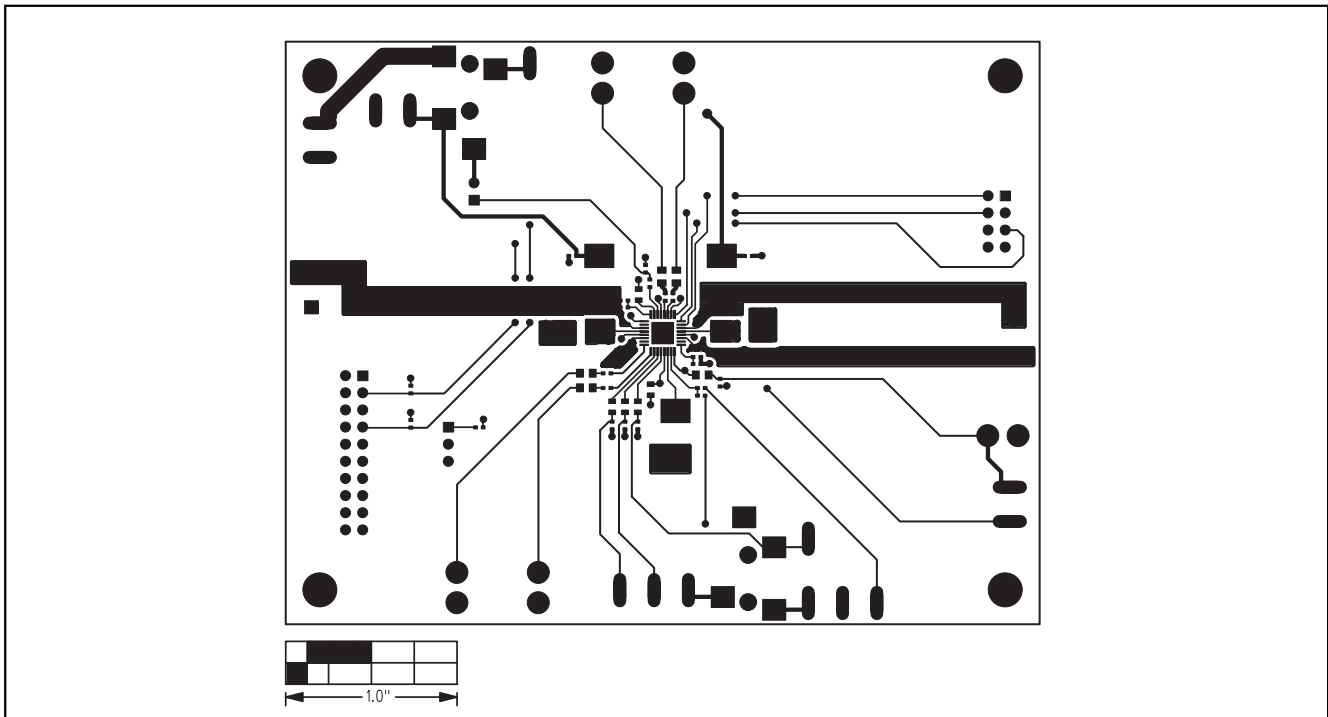

Figure 6. MAX9765 EV Kit PC Board Layout—Component Side

MAX9765 Evaluation System/Evaluation Kit

Evaluates: MAX9765

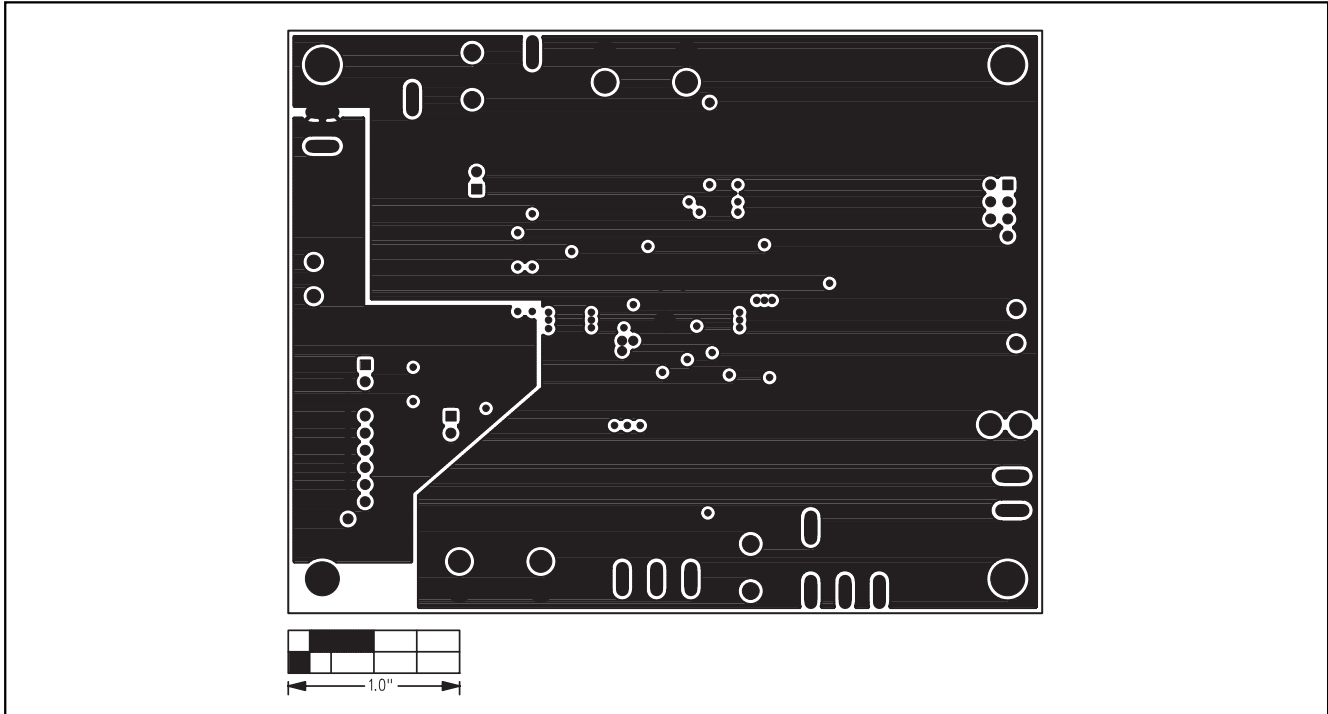

Figure 7. MAX9765 EV Kit PC Board Layout—Inner Layer 2

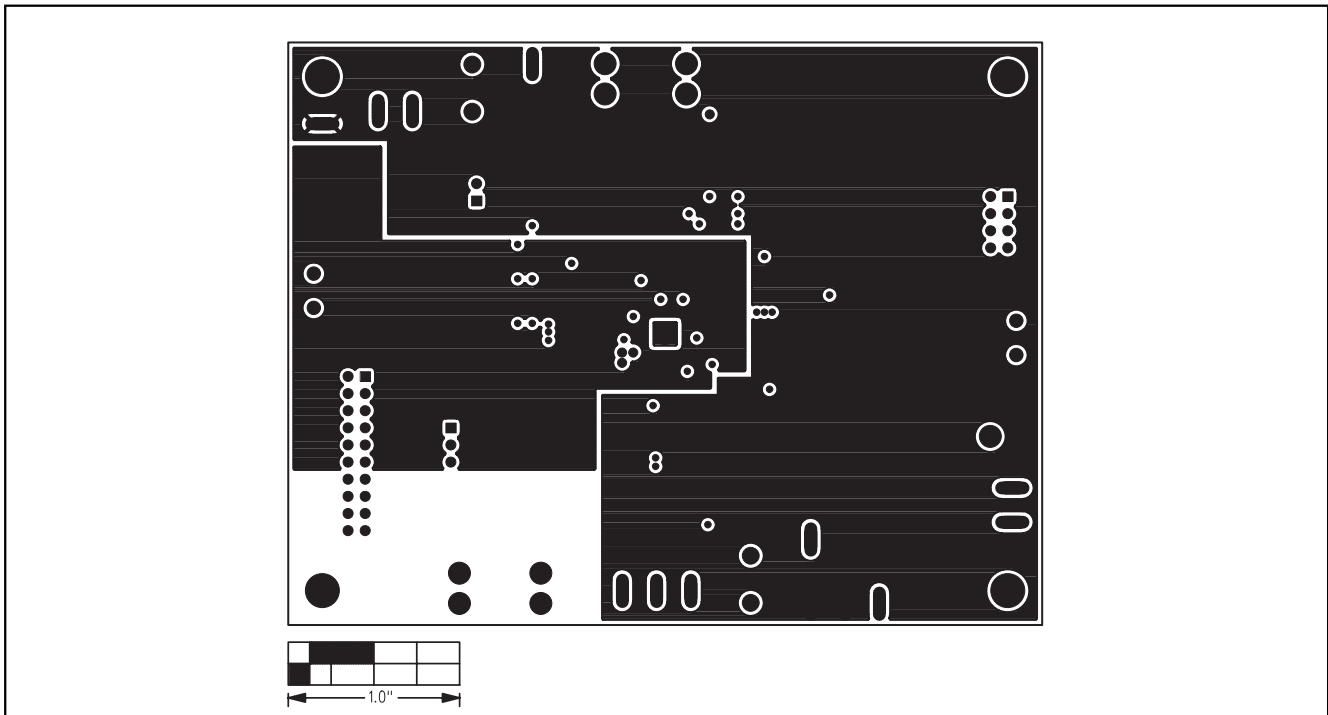

Figure 8. MAX9765 EV Kit PC Board Layout—Inner Layer 3

MAX9765 Evaluation System/Evaluation Kit

Evaluates: MAX9765

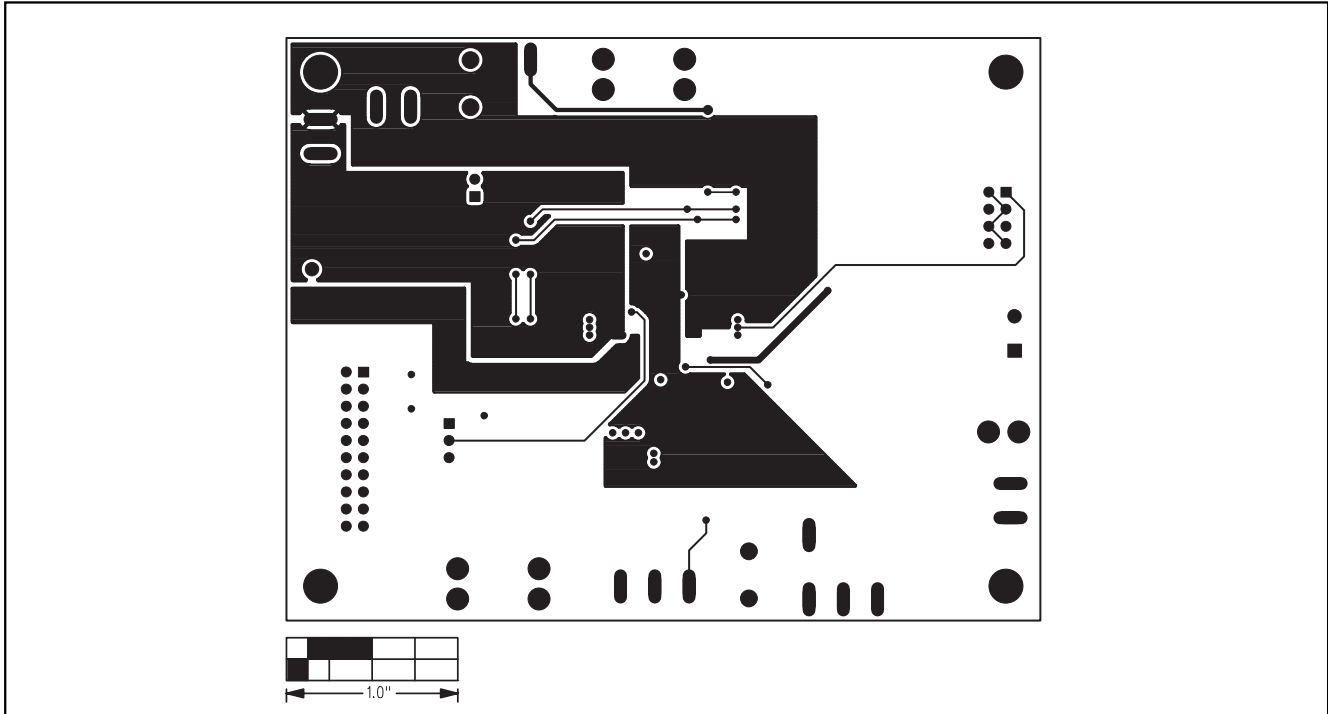

Figure 9. MAX9765 EV Kit PC Board Layout—Solder Side

Maxim cannot assume responsibility for use of any circuitry other than circuitry entirely embodied in a Maxim product. No circuit patent licenses are implied. Maxim reserves the right to change the circuitry and specifications without notice at any time.

10 _____ **Maxim Integrated Products, 120 San Gabriel Drive, Sunnyvale, CA 94086 408-737-7600**